

Installation

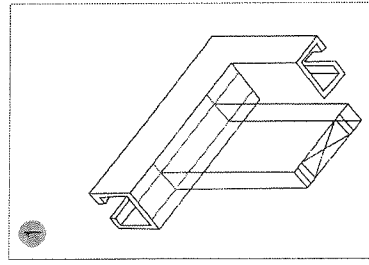

1 Place lock body template to match with door frame center line

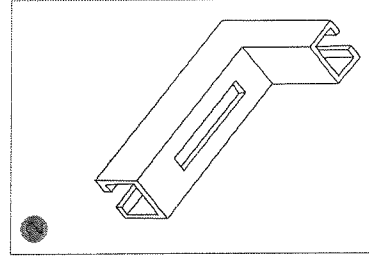

2 Cut hole

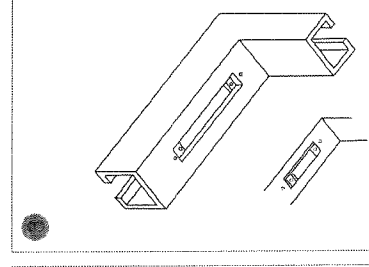

3 Fix mounting plate (For hollow metal frame)

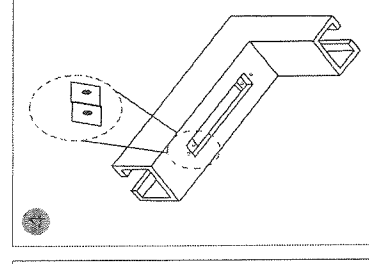

4 Connect wires

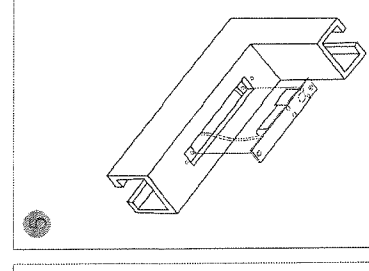

5 Mount lock body on the door frame and test

Installation Schematic

Suitable for 10-15mm glass door, Suitable for Frameless Glass Door.

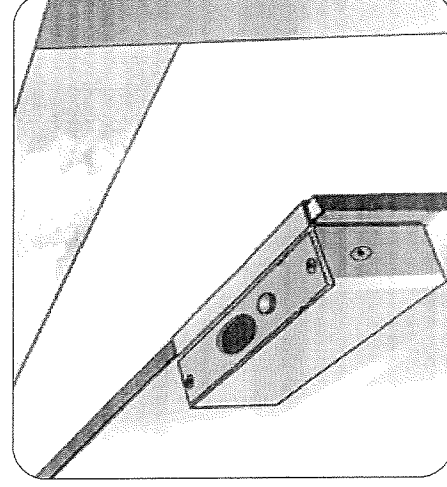
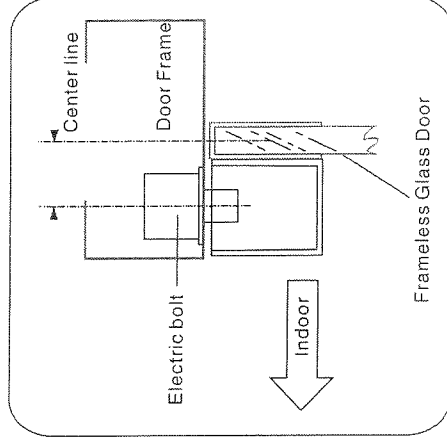

Wiring Diagram

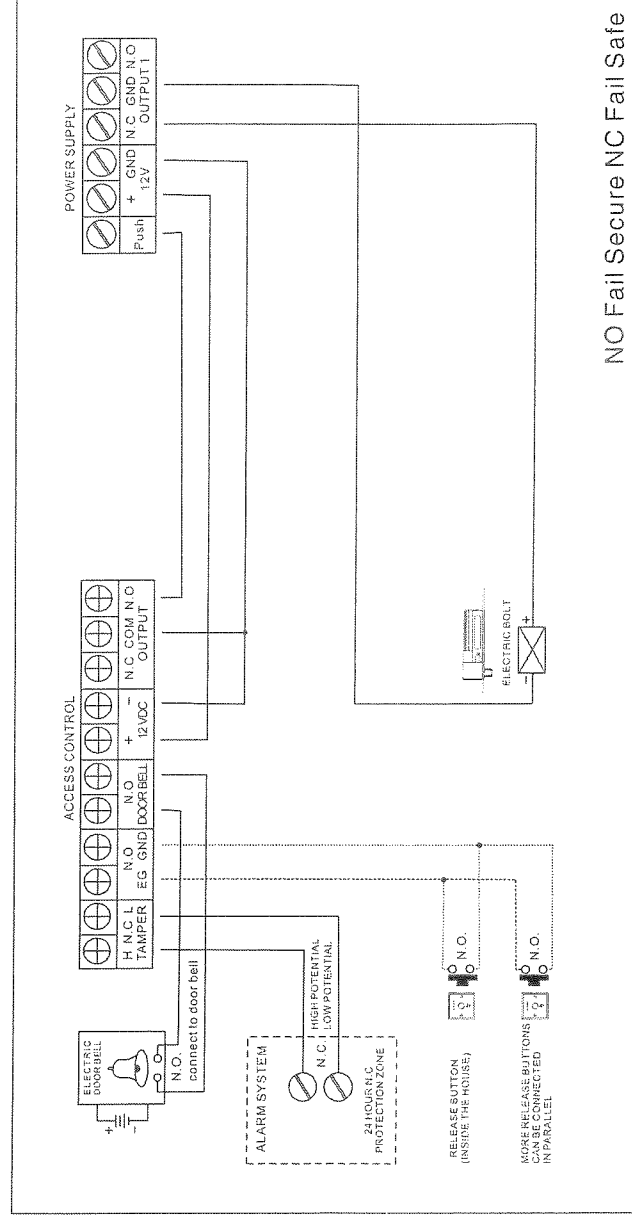

NO Fail Secure NC Fail Safe

Fail Safe Sturdiness Electric Bolt

Parameters

Face Plate	192Lx25Wx37H(mm)
Strike	92Lx25Wx3H(mm)
Bolt	16(projecture)*13(diameter)(mm)
Holding Force	1000Kg
Time Delay	0/3/6/9sec(Adjustable)
Voltage	12VDC
Current	Start 960mA,Standby 180mA
Signal Output	Door signal NO/COM
LED	Green indicates the door is unlock; Red indicates the door is lock
Material	304 stainless steel, wire draw finishing
Induction Distance	8mm
Suitable for	Wooden door, glass door, metal door ,Fireproof door
Temperature.	-40~+60℃
Weight	0.68kg

Dimensions

